

File System Forensics

FAT and NTFS

FAT File Systems

File Allocation Table (FAT) File Systems

- Simple and common
- Primary file system for DOS and Windows 9x
- Can be used with Windows NT, 2000, and XP
 - New Technologies File System (NTFS) is default for NT, 2000, and XP
- Supported by all Windows and UNIX varieties
- Used in flash cards and USB thumb drives

The FAT Family

- FAT12, FAT16, FAT32
 - The number refers to the quantity of bits used in the FAT to refer to clusters



Copyright Priscilla Oppenheimer

Disk Storage Review

- Data is stored on disks one entire sector at a time
 - A sector is usually 512 bytes
 - If you use only one byte, the system still provides the other 511 bytes for you
 - A sector is the minimum size read from, or written to, a disk
 - A sector is the minimum I/O unit

Disk Storage Review (cont.)

- Space is allocated to a file one cluster at a time
 - A cluster is a fixed number of sectors
 - Must be a power of 2 (1,2,...64)
 - Unused sectors retain the data that was on them prior to allocation
 - A cluster is the minimum file allocation unit

Clusters

Cluster 1

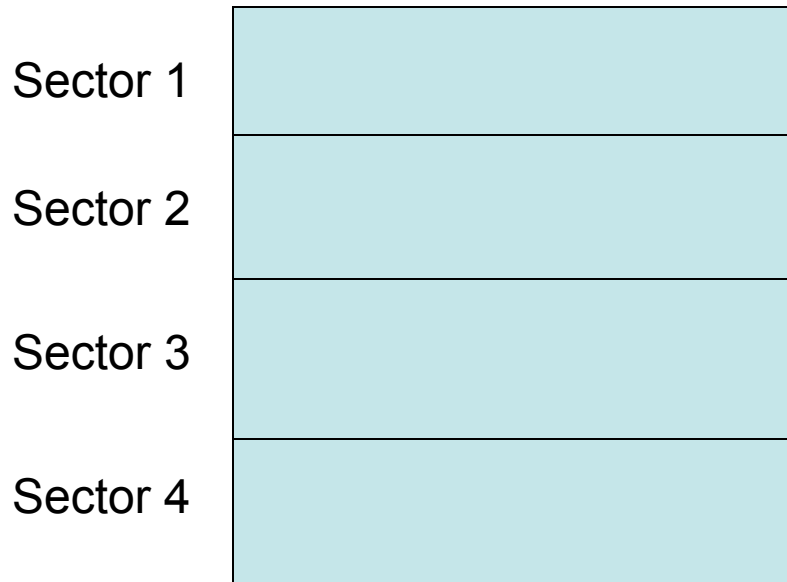

Cluster 2

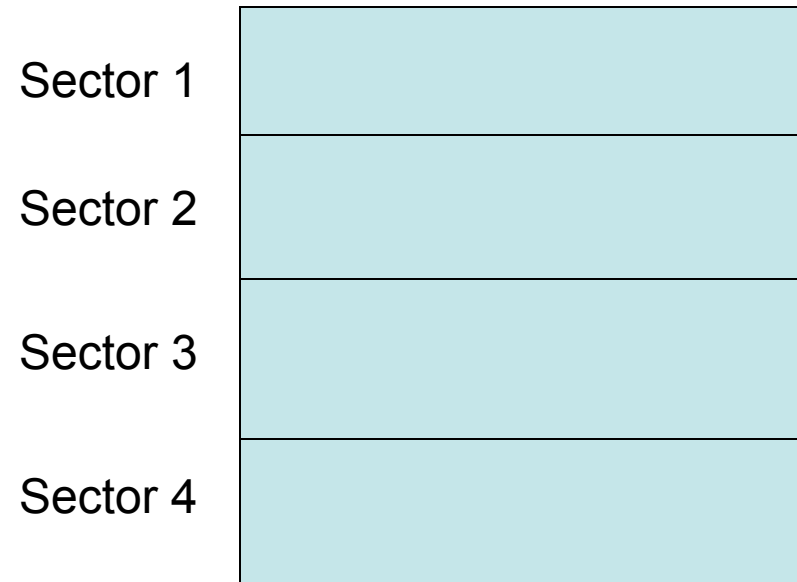

File Data (Example 1)

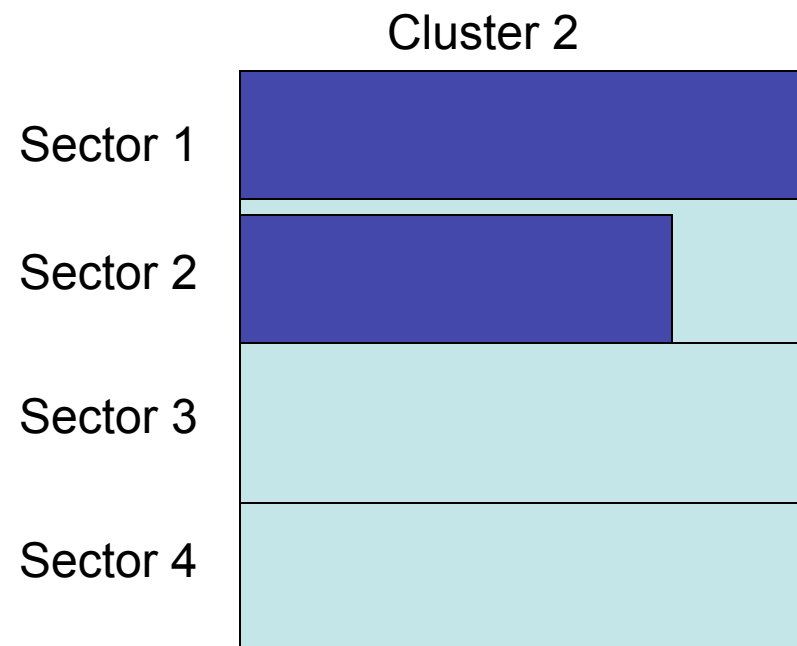
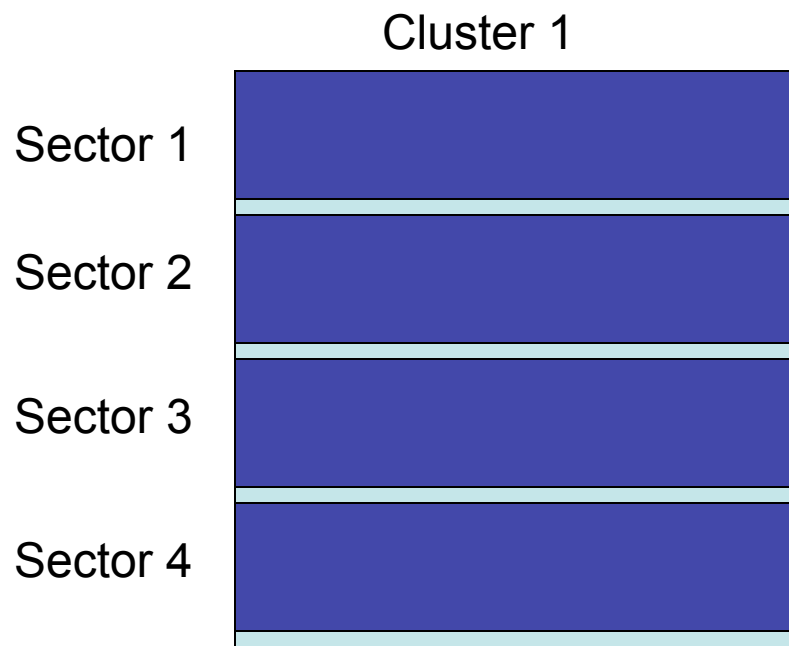

File Data (Example 2)

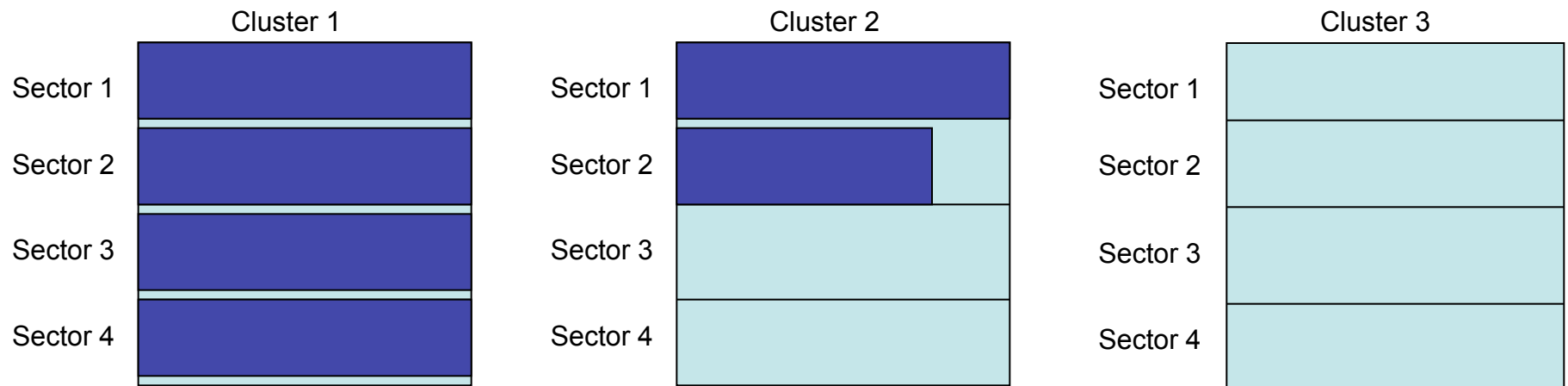

Slack

- **Slack is the space allocated to a file, but unused**
 - Space at the end of a sector that remains unused by the file
 - Sectors allocated to the file that the file hasn't yet used
- **Slack space often contains useful evidence**
 - Unused bytes in an allocated sector are less useful
 - Unused sectors in an allocated cluster retain their original contents and are very useful

Unallocated Clusters

- Many clusters on a modern hard drive are unallocated
- Unallocated clusters may have been allocated earlier though
 - These clusters retain their data until they are reallocated to a new file
 - Deleted files are still recoverable!



Cluster Allocation Algorithms

- First available
 - Always start at the beginning of the file system
 - Fragmented files common
 - Recovery of deleted content better at end of file system

Cluster Allocation Algorithms

- Best fit
 - Search for consecutive clusters that fit the size of file
 - Only works for files that don't grow
- Next available
 - Start search with the cluster that was most recently allocated
 - More balanced for data recovery
 - Used by Windows 98 and XP

Partitions Review

- The user creates partitions (logical drives or volumes)
 - Creates Master Boot Record with partition table
 - Each partition uses a file system
 - FAT12, FAT16, FAT32, NTFS on Windows systems
 - EXT2, EXT3, UFS1, UFS2 on Linux and UNIX systems
- Recovery tools can often find data even if the disk was repartitioned
 - Look for tell-tale symptoms of a file system
 - FAT file systems have 0x55AA in bytes 510 and 511 of the partition, for example

Partitions Review

- MBR in first 512-byte sector on disk
 - Boot code (Bytes 0-445)
 - Partition table (bytes 446-509)
 - Signature (bytes 510-511, value = 0x55AA)
- Partition table has four entries
 - Disk has four primary partitions
 - A primary partition may hold extended partitions

Disk

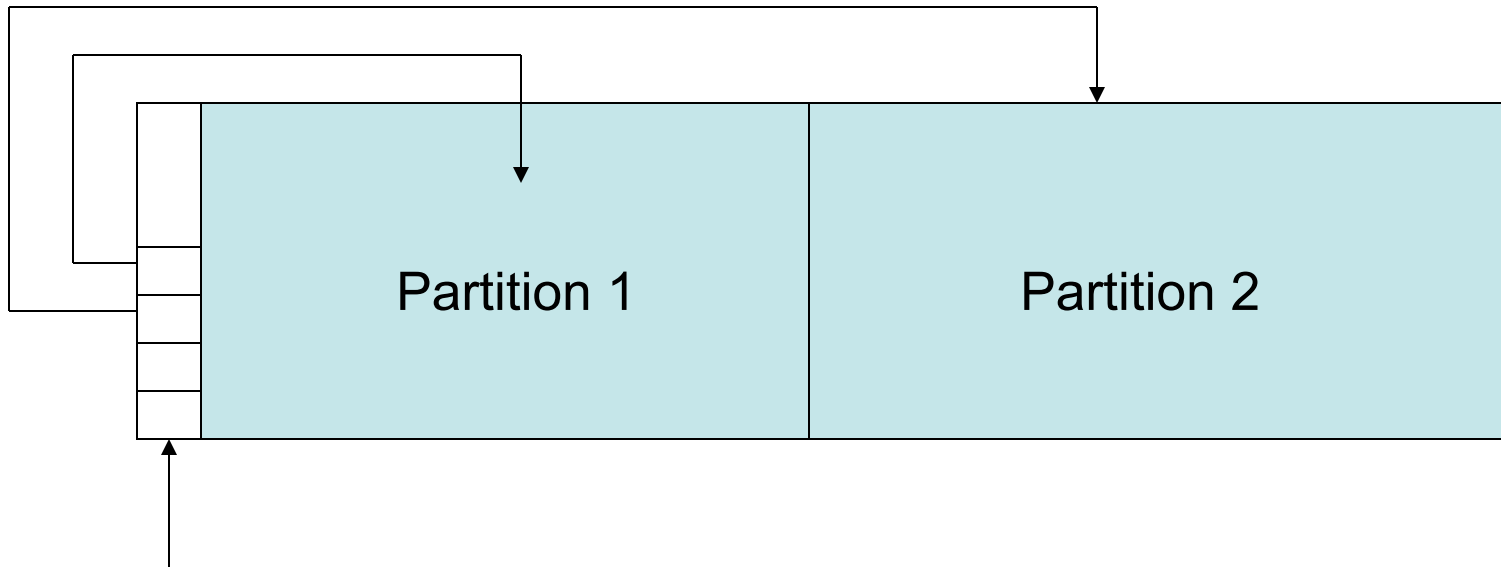

Master Boot Record
Including Partition Table
& Signature

File Systems

- High-level formatting creates file system data structures
 - Root directory
 - Data that tracks which clusters are unused, allowing the OS to find available clusters quickly
 - File Allocation Table (FAT) on older Windows systems
 - \$Bitmap in the Master File Table (MFT) on newer Windows
 - Exact details depend on operating system

Partition Holds a File System from the FAT Family

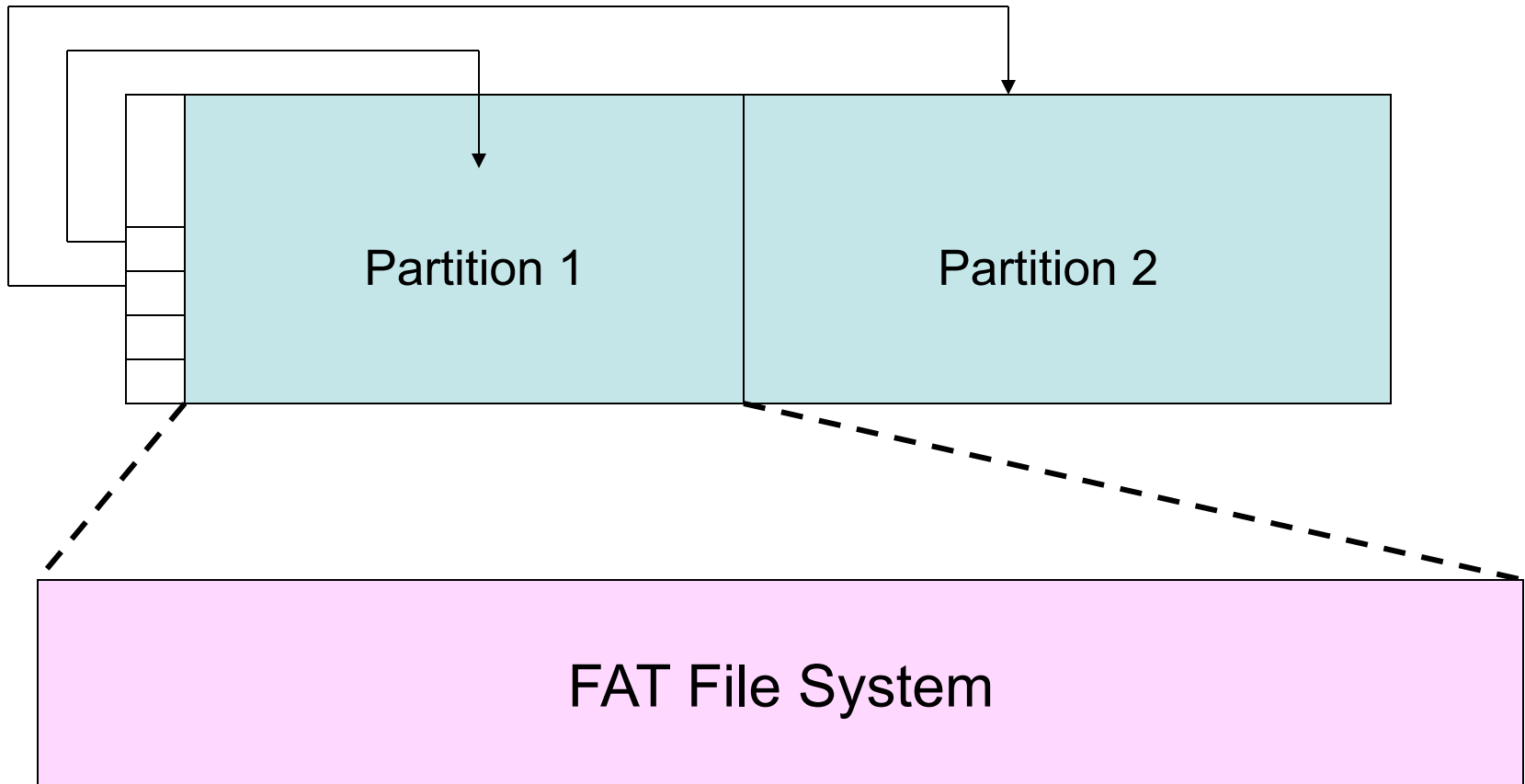

FAT Family File System

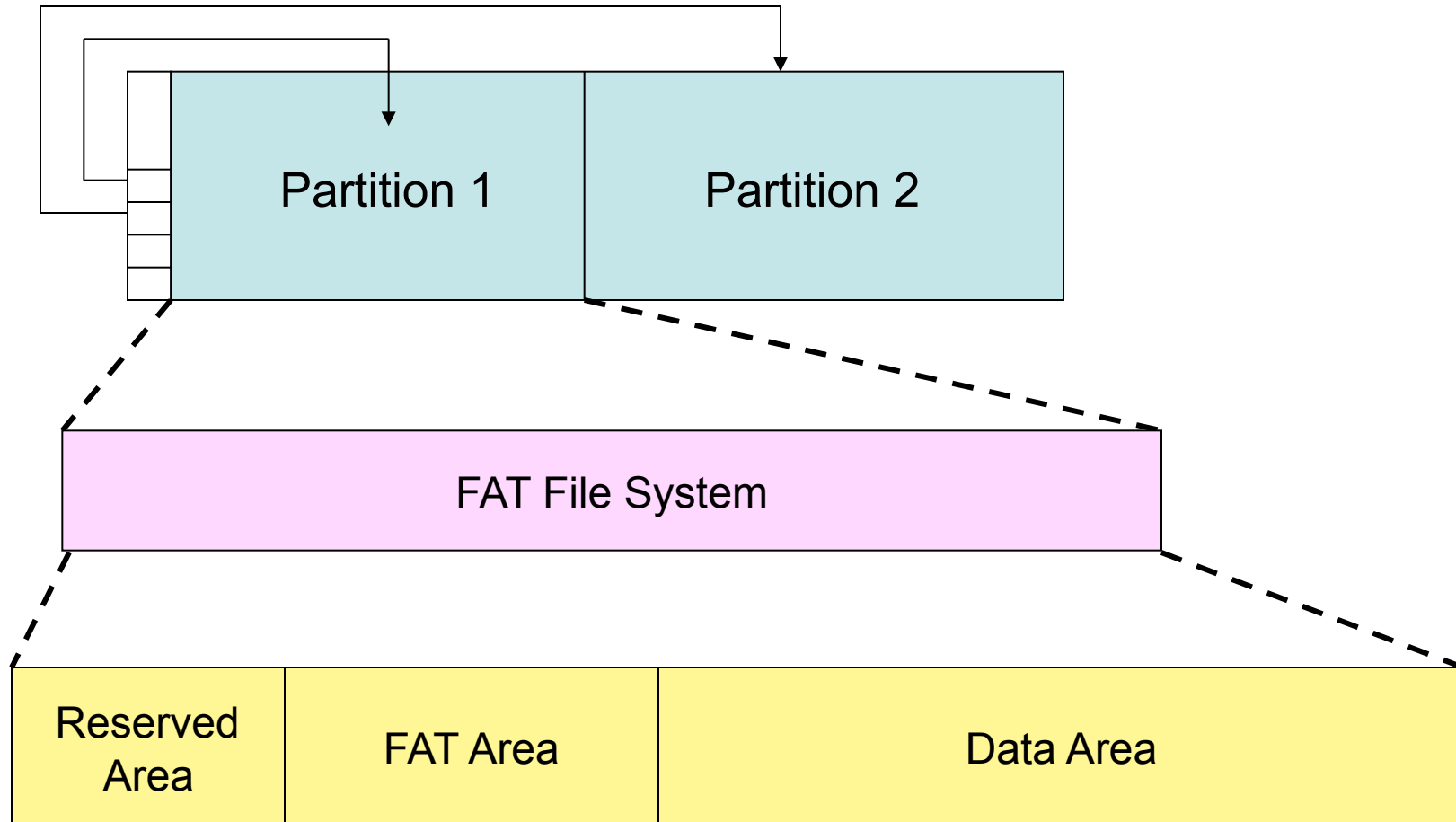

FAT File System Layout

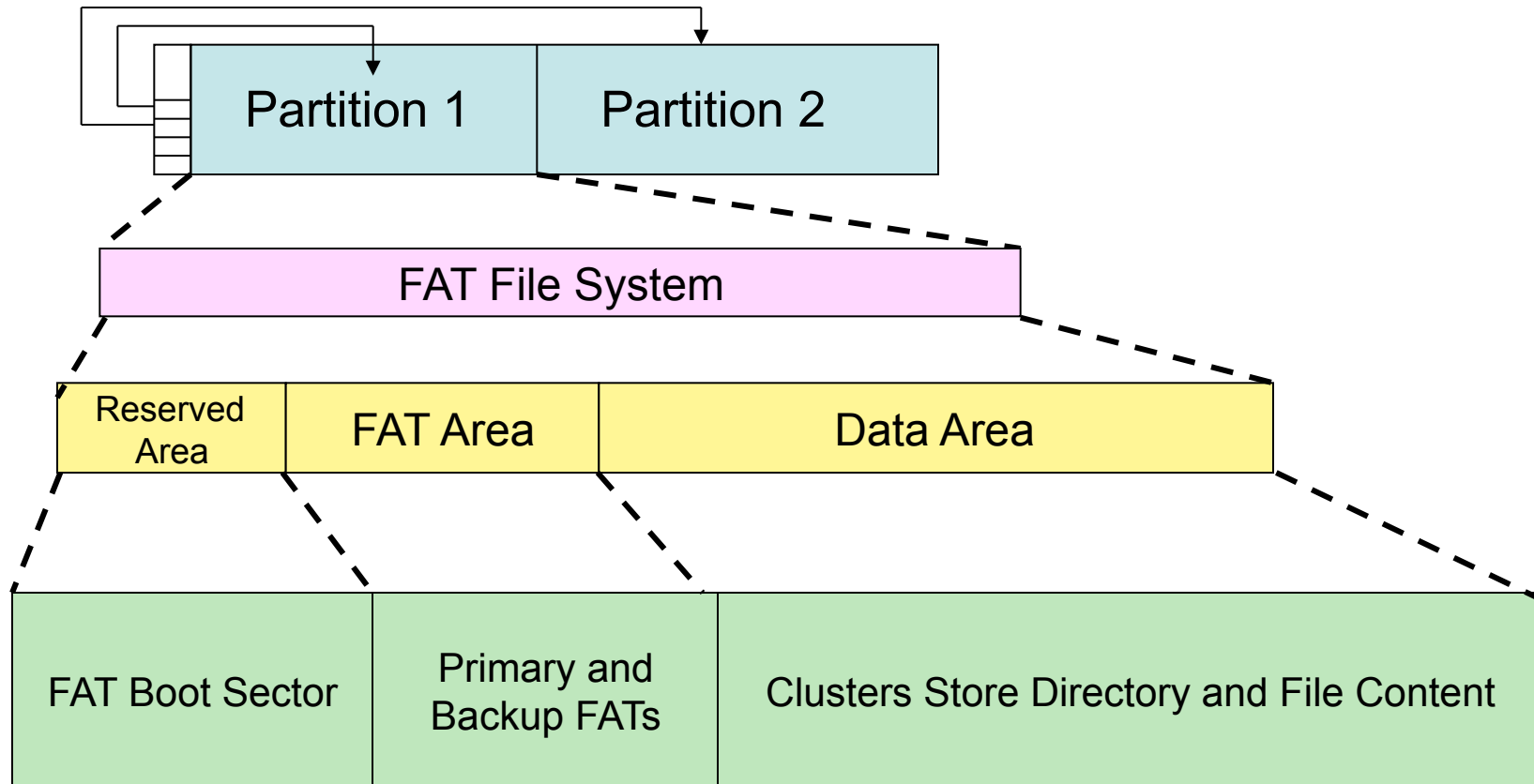

FAT File System Boot Sector

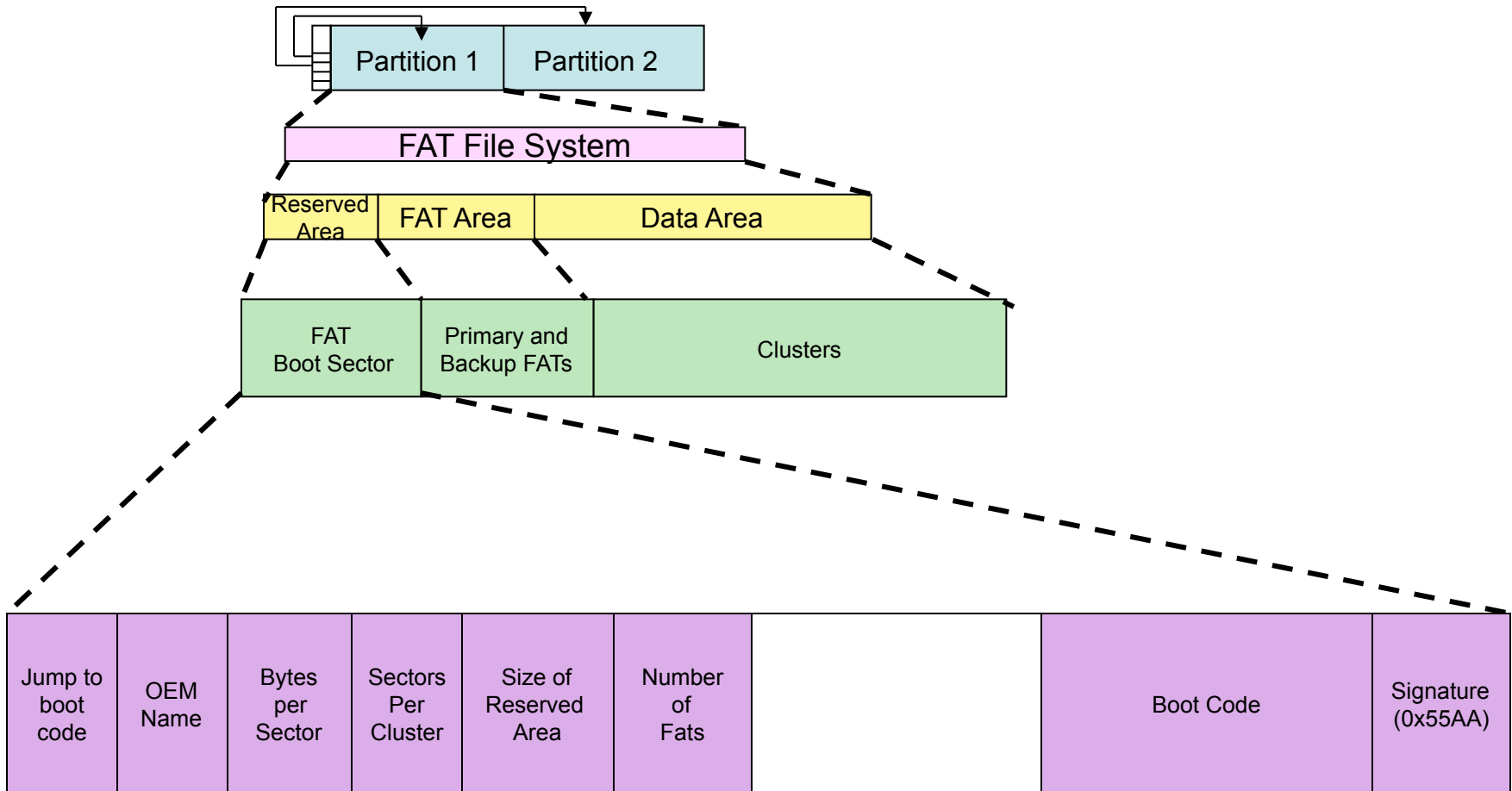

FAT32 Boot Sector

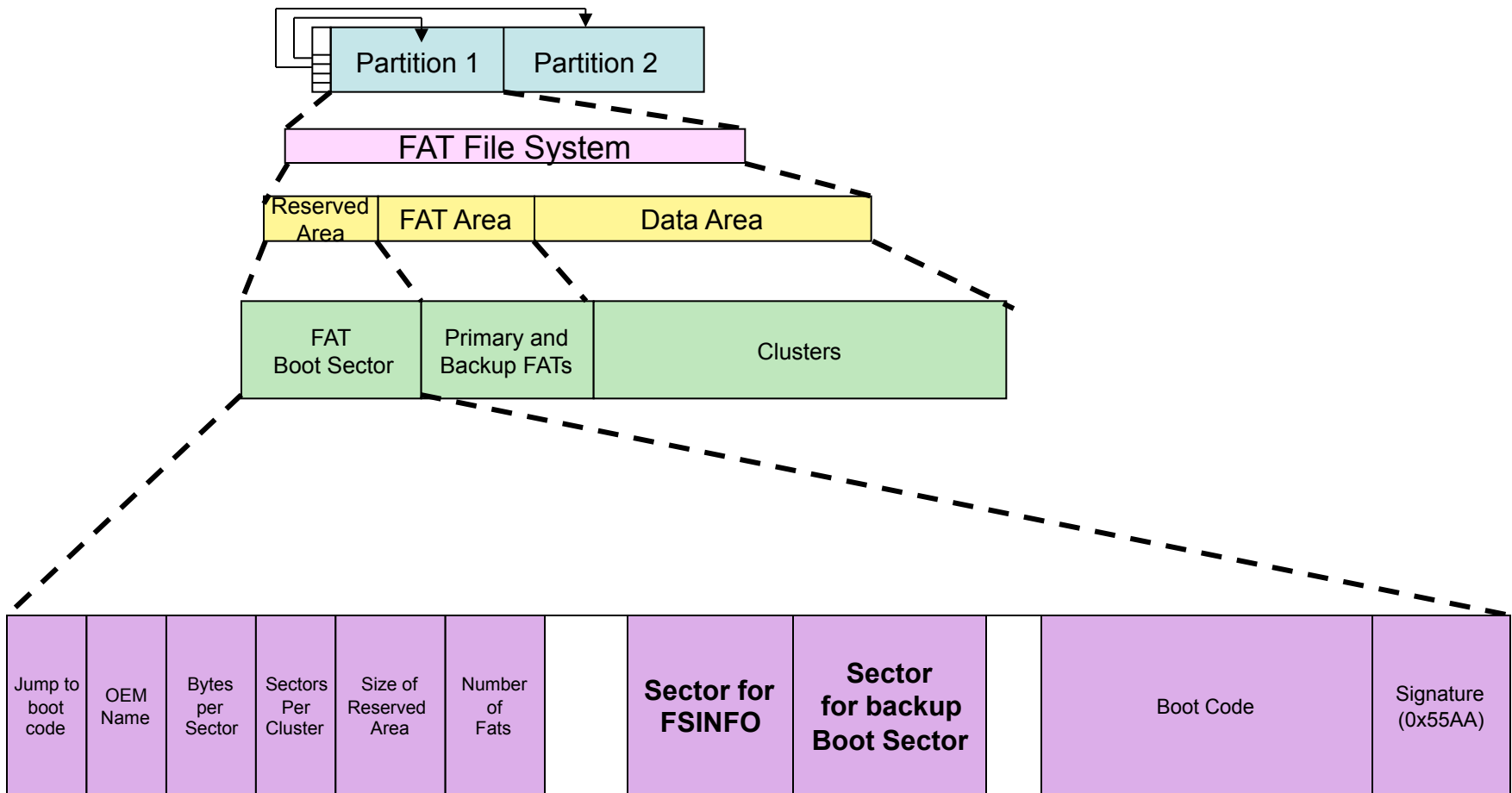

FAT32 FSINFO

Hints about where the OS can find free clusters

Byte Range	Description
0-3	Signature (0x41615252)
4-483	Not Used
484-487	Signature (0x61417272)
488-491	Number of free clusters
492-495	Next free cluster
496-507	Not Used
508-511	Signature (0x55AA0000)

FAT Entries

- 12, 16, or 32 bits
- First addressable cluster is cluster 2
- In FAT16, non-addressable cluster 0 stores the media type
 - 0xF0 means removable
 - 0xF8 means non-removable
 - Duplicates byte 21 of volume boot record
- In FAT16, non-addressable cluster 1 stores the dirty status of the file system

File Allocation Table Concepts

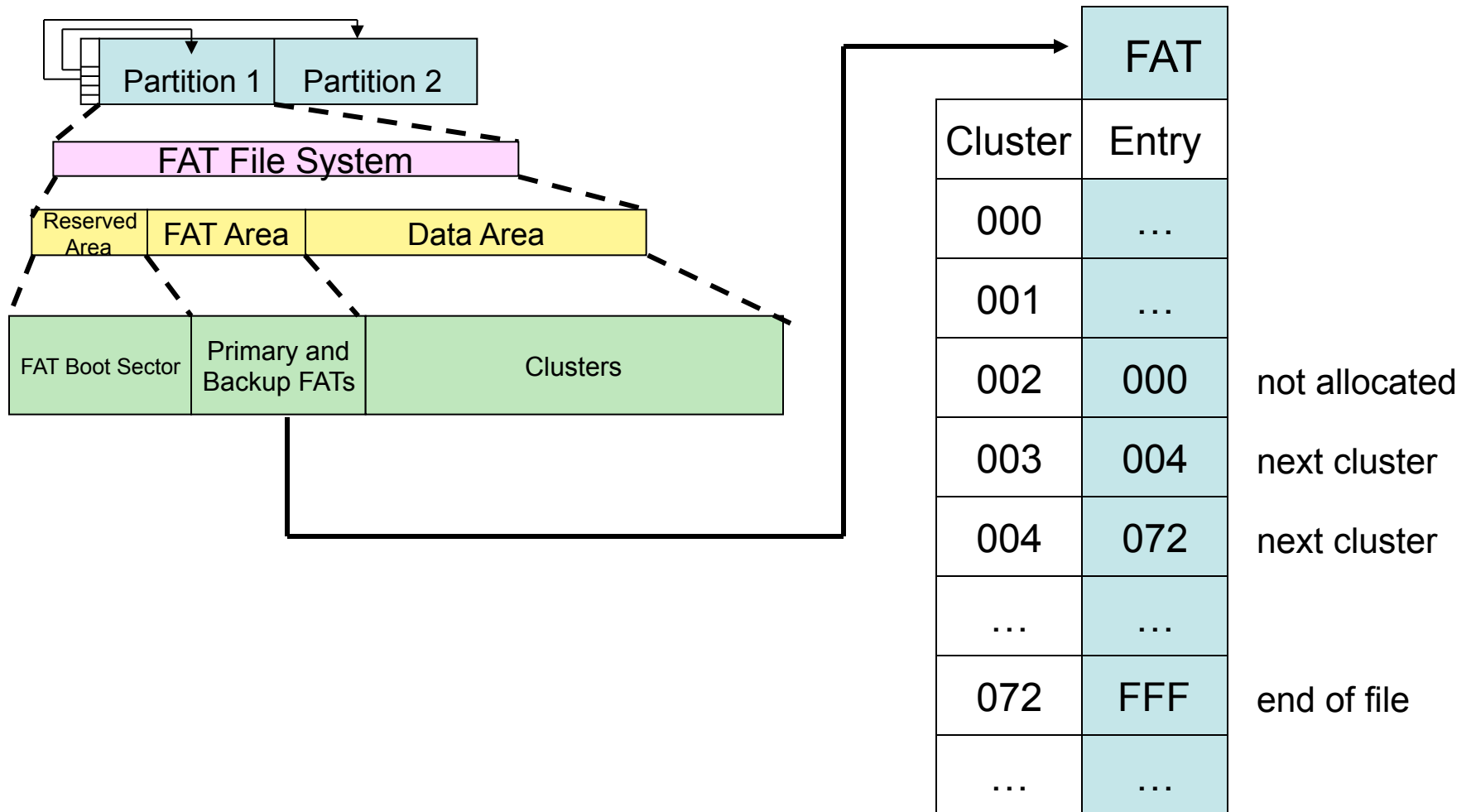

End of File and Bad Cluster

- End-of-file marker
 - Greater than 0xFF8 for FAT12
 - Greater than 0xFFF8 for FAT16
 - Greater than 0xFFFF FFF8 for FAT32
- Bad cluster
 - 0xFF7 for FAT12
 - 0xFFF7 for FAT16
 - 0x FFFF FFF7 for FAT32

Data Area Concepts

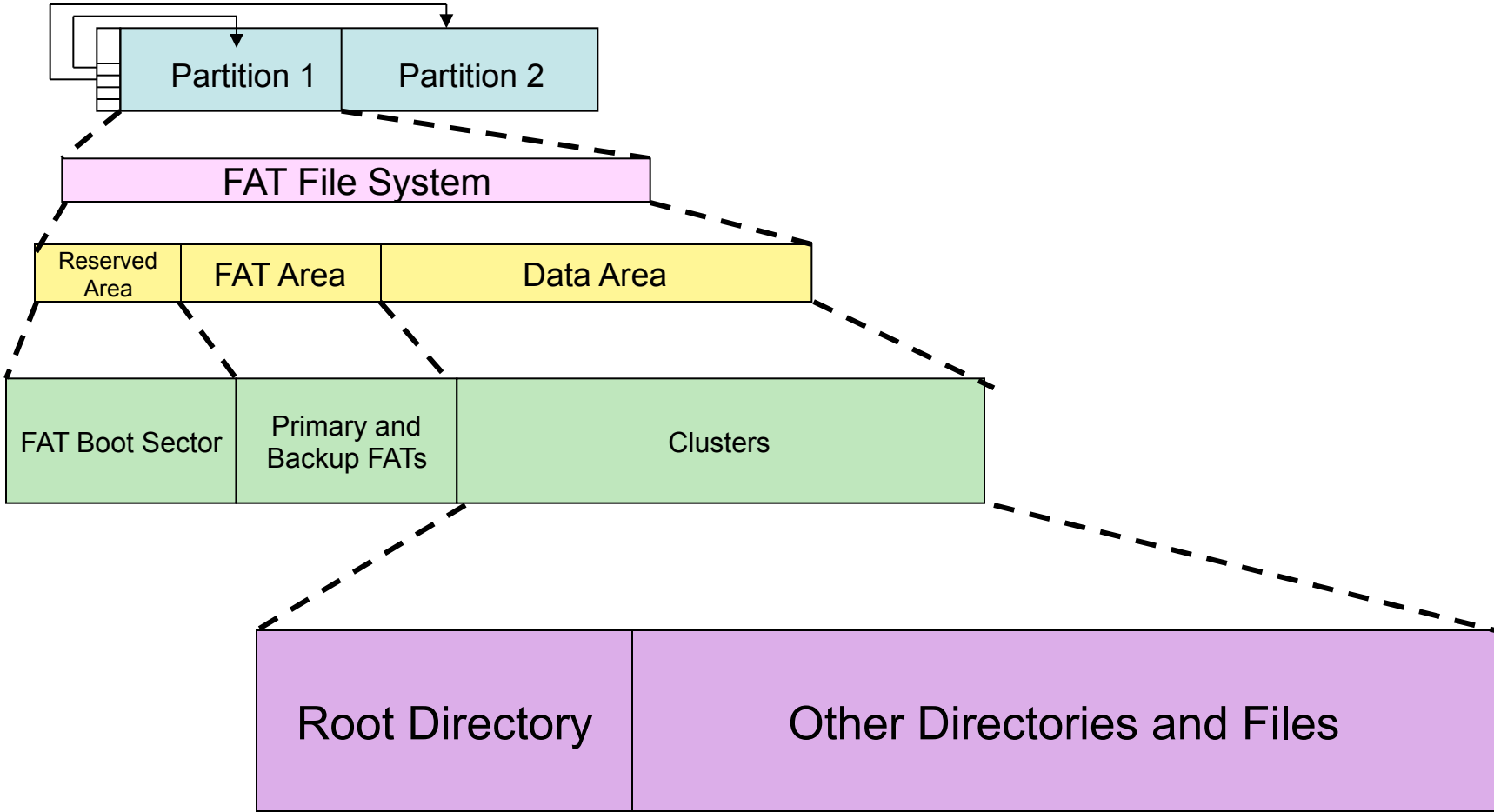

Root Directory

- Fixed length in FAT12/16
 - 32 sectors
 - Each entry is 32 bytes
 - 512 entries total
 - Starts before cluster 2
- Not fixed length in FAT32
 - Starts at cluster 2
 - Each entry is still 32 bytes

FAT Directories

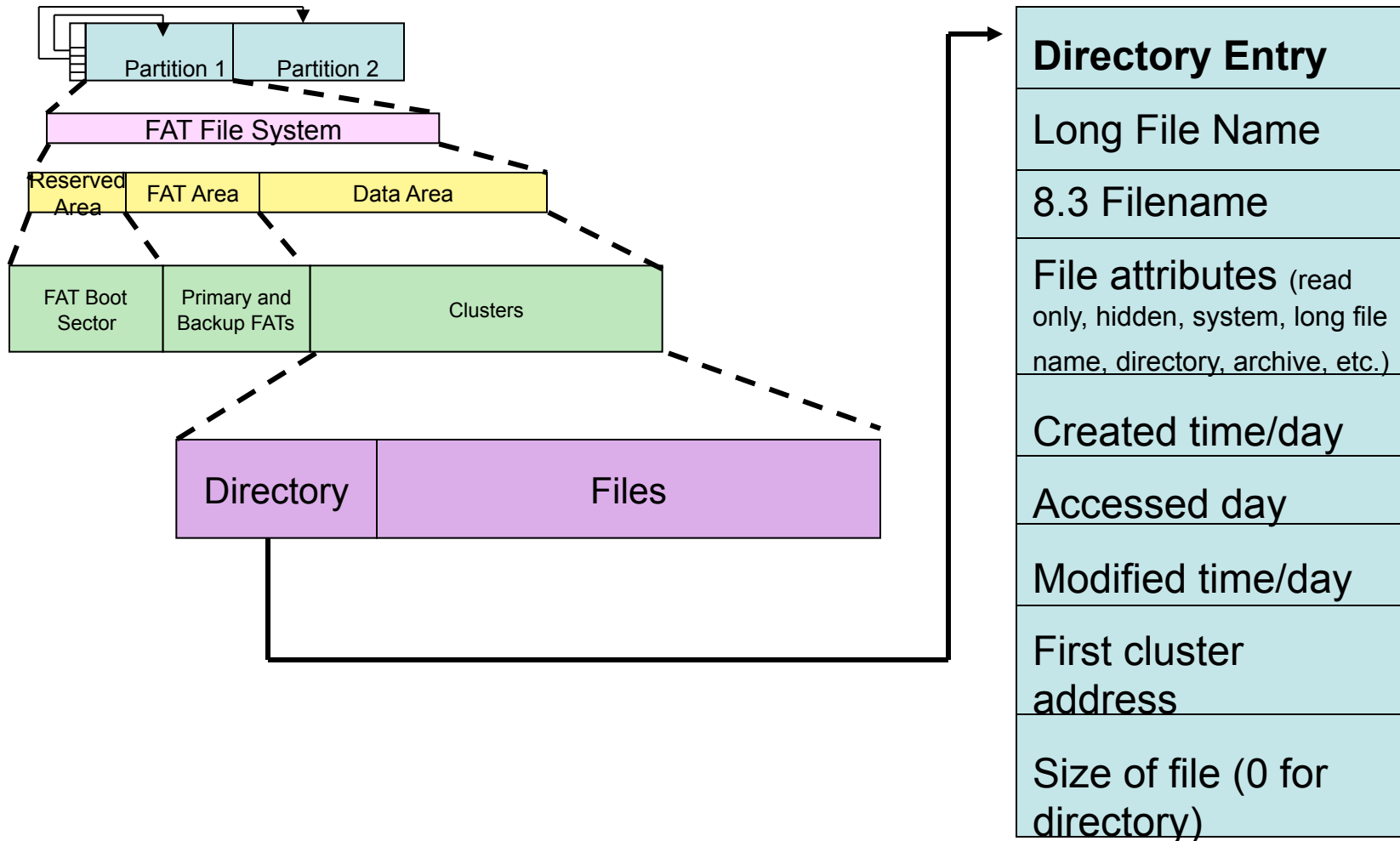

Deleting a FAT File

Deleting dir1\file1.txt

1. Read Fat Boot Sector (sector 0 of the volume) to understand structure and location of Reserved, FAT, and Data areas
2. Locate dir1 in Root Directory; determine its starting cluster
3. Go to dir1 cluster; determine starting cluster for file1.txt
4. Set FAT entries for file1.txt to 0
5. Change filename to σ ile1.txt in dir1 directory
 - First character becomes 0xE5

Directory and FAT

Directory

First cluster used by file



file1.txt	02C
file2	
file3	
file4	

FAT

000	...		
001	...		
002	...		
	...		
02C	0	2	D
02D	0	2	E
02E	F	F	F
	...		

Directory and FAT

Deleted file

Directory

First cluster used by file



file1.txt	02C
file2	
file3	
file4	

FAT

000	...
001	...
002	...
	...
02C	0 0 0
02D	0 0 0
02E	0 0 0
	...

Recovering Files

- Easy if file isn't fragmented and clusters haven't been reallocated!
 - Go to directory entry
 - Change the first character of the file name from 0xE5 to original (or guess if original can't be derived)
 - Go to FAT for first cluster
 - Get that cluster and the next consecutive clusters (depending on size of file)

It's Not Perfect

- Potential problems
 - Fragmented files
 - Clusters that have been overridden
 - Missing directories or directory entries
 - Although the dot and dot dot entries may help
- Best bet will be when fragmentation is minimal and the deletion was recent
 - Usually errors in recovery are obvious
 - Partial recovery is better than nothing!

New Technologies File System (NTFS)

NTFS

- Default file system for Windows NT, 2000, XP, and Windows Server 2003
- No published spec from Microsoft that describes the on-disk layout
- Windows 2000 and XP use a newer form of NTFS called NTFS5.
- Good sources for NTFS information
 - [Linux NTFS Project](#)
 - www.ntfs.com

Microsoft NTFS Goals

- Provide a reliable, secure, scalable, and efficient file system
- Get a foothold in the lucrative business and corporate markets
- Some concepts borrowed from OS/2 High Performance File System (HPFS)

NTFS Features

- Logging
 - Transaction-based
- File and folder permissions
- Disk quotas
- Reparse points (used to link files)
- Sparse file support
- Compression
- Encryption
- Alternate data streams

Sparse Files

- Clusters that contain all zeros aren't written to disk
- Analysis considerations
 - A deleted sparse file is hard to recover
 - If file system metadata is deleted or corrupted, a sparse file might not be recoverable

File Compression

- Data is broken into equal-sized compression units (e.g. 16 clusters)
- An attempt is made to compress each unit
- Parts of a file may be compressed while other parts aren't

File Compression Analysis Considerations

- A single file can use different compression methods (e.g. none, sparse, or variant of [LZ77](#))
- Recovery tools need to support decompression
- A deleted compressed file is hard to recover
- If file system metadata is deleted or corrupted, a compressed file might not be recoverable

Encrypting File System (EFS)

- Uses both symmetric key encryption (DESX) and asymmetric key encryption (RSA)
- Generates a single file encryption key (FEK) and encrypts file with FEK using DESX
- Encrypts FEK with RSA
- Stores FEK with file

File Encryption Key Encryption

- FEK is encrypted with user's public key
- FEK is decrypted with user's private key
- If policy allows it, FEK is also encrypted with public key of recovery agent (and decrypted with private key of recovery agent)

File Encryption

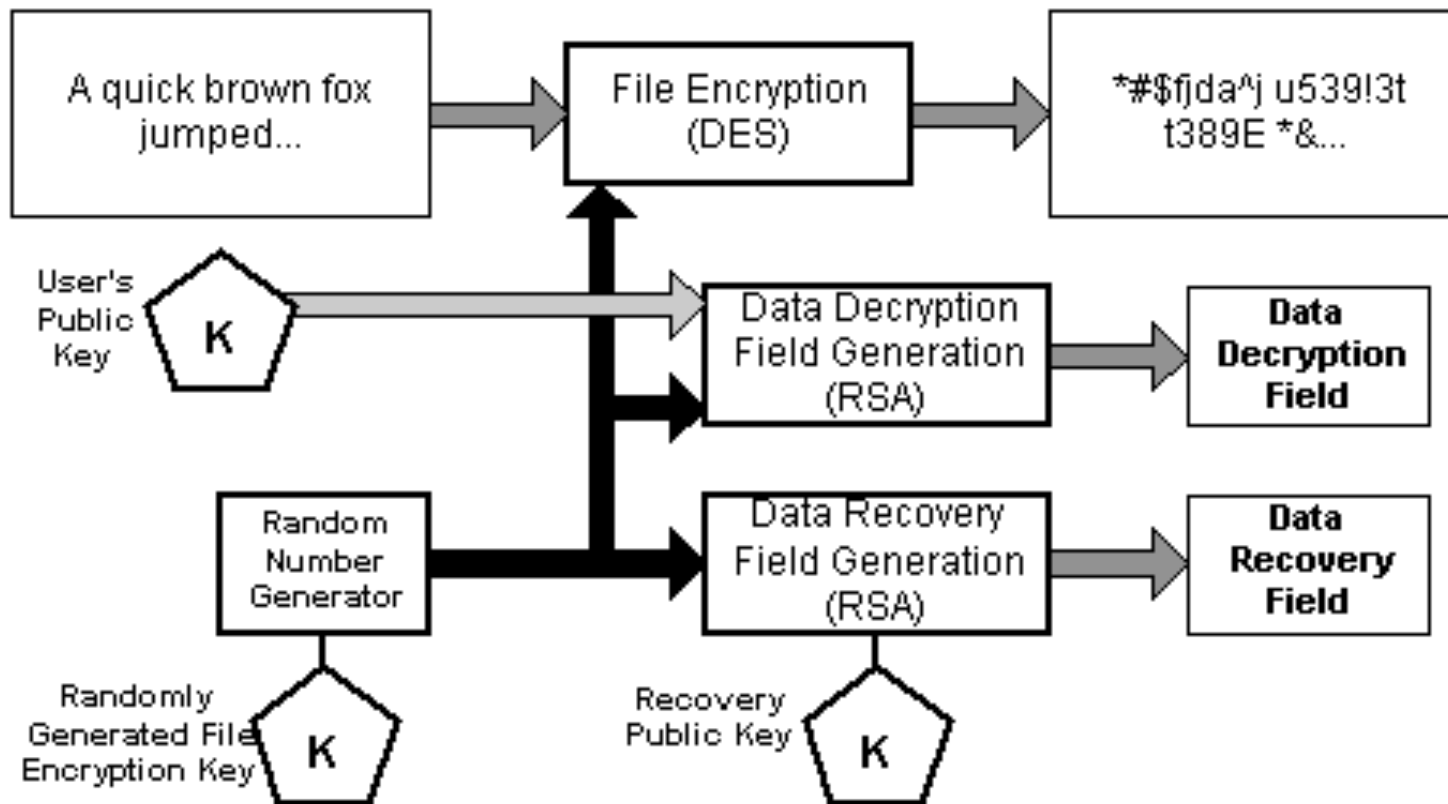

Source: NTFS.com

Copyright Priscilla Oppenheimer

EFS Analysis Considerations

- By default a user's private key is stored in the Windows registry, encrypted with login password as key
 - Login password is susceptible to brute force attack and private key might be compromised
- EFS creates a temporary file (EFS0.TMP) with plaintext data
 - Marks it as deleted when finished but doesn't actually erase contents

Alternate Data Streams

- Data added to a file
- Introduced to support Macintosh files that have a data and resource fork
- Almost impossible to detect with normal file browsing techniques
- A favorite of hackers and criminals

Creating an ADS

- To create an ADS named foo to go with the file.txt file, use the following DOS command
 - echo "Hello There" > file.txt:foo

Another ADS Example

```
Directory of C:\adstest
02/14/2004  04:47p    <DIR>      .
02/14/2004  04:47p    <DIR>      ..
07/26/2000  09:00a             91,408 calc.exe
              1 File(s)          91,408 bytes
              2 Dir(s)    684,425,216 bytes free

C:\adstest>type c:\winnt\system32\notepad.exe>calc.exe:notepad.exe
█

C:\adstest>dir
Volume in drive C has no label.
Volume Serial Number is 8C3F-115B

Directory of C:\adstest
02/14/2004  04:47p    <DIR>      .
02/14/2004  04:47p    <DIR>      ..
02/14/2004  04:51p             91,408 calc.exe
              1 File(s)          91,408 bytes
              2 Dir(s)    684,371,968 bytes free

C:\adstest>
```

Source: WindowSecurity.com

Start the Program

```
Directory of C:\adstest
02/14/2004  04:47p      <DIR>      .
02/14/2004  04:47p      <DIR>      ..
02/14/2004  04:51p                91,408 calc.exe
                1 File(s)                91,408 bytes
                2 Dir(s)          684,371,968 bytes free

C:\adstest>start c:\adstest\calc.exe:notepad.exe
C:\adstest>
```

What Program Is Running?

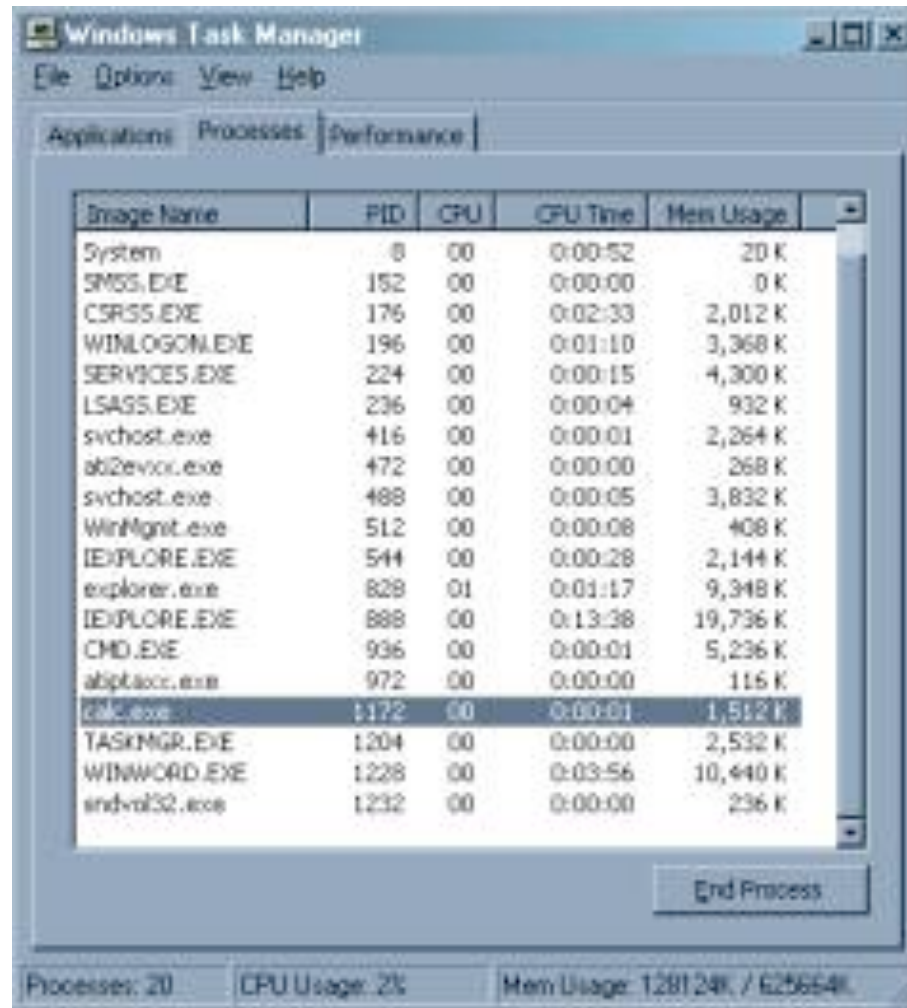

The screenshot shows the Windows Task Manager window with the Performance tab selected. The Processes tab is also visible. The Performance tab shows system statistics: Processes: 20, CPU Usage: 2%, and Mem Usage: 128124K / 625654K. The Processes tab is active, displaying a list of running processes with columns for Image Name, PID, CPU, CPU Time, and Mem Usage. The process calc.exe is highlighted.

Image Name	PID	CPU	CPU Time	Mem Usage
System	0	00	0:00:52	20 K
SMSS.EXE	152	00	0:00:00	0 K
CSRSS.EXE	176	00	0:02:33	2,012 K
WINLOGON.EXE	196	00	0:01:10	3,368 K
SERVICES.EXE	224	00	0:00:15	4,300 K
LSASS.EXE	236	00	0:00:04	932 K
svchost.exe	416	00	0:00:01	2,264 K
ab2evccr.exe	472	00	0:00:00	268 K
svchost.exe	488	00	0:00:05	3,832 K
WinMgmt.exe	512	00	0:00:08	408 K
IEXPLORE.EXE	544	00	0:00:28	2,144 K
explorer.exe	828	01	0:01:17	9,348 K
IEXPLORE.EXE	888	00	0:13:38	19,736 K
CMD.EXE	936	00	0:00:01	5,236 K
abptaccr.exe	972	00	0:00:00	116 K
calc.exe	1172	00	0:00:01	1,512 K
TASKMGR.EXE	1204	00	0:00:00	2,532 K
WINWORD.EXE	1228	00	0:03:56	10,440 K
endvol32.exe	1232	00	0:00:00	236 K

NTFS Basic Concepts

- Everything is a file
- Files have attributes
 - \$SOME_UPPER_CASE_THING
 - \$FILE_NAME
 - \$STANDARD_INFORMATION
 - Creation, altered, accessed times; flags (read only, hidden, system, archive, etc.)
 - \$DATA (the actual content)

File System Metadata Files

- Files that store file system administrative data
- Note that they are files (unlike FAT which was a separate data structure)
- Name begins with \$ and first letter is capitalized
 - \$MFT
 - \$LogFile

Master File Table

- Contains information about all files and directories
- Every file and directory has at least one entry in the table
- Each entry is simple
 - 1 KB in size
 - Entry header is first 42 bytes
 - Remaining bytes store attributes

File System Metadata Files

First 16 MFT Entries Are Reserved

Entry	File Name	Description
0	\$MFT	Entry for MFT itself
1	\$MFTMirr	Backup of MFT
2	\$LogFile	Journal
3	\$Volume	Volume label, etc.
4	\$AttrDef	IDs for attributes
5	/	Root directory
6	\$Bitmap	Allocation status of clusters
7	\$Boot	Boot sector
8	\$BadClus	Clusters with bad sectors

Resident and Non-Resident Attributes

- A resident attribute stores its content in the MFT entry
- A non-resident attribute stores its content in external clusters
- Non resident attributes are stored in cluster runs
- The attribute header gives the starting cluster address and its run length

Non-Resident Attributes

- \$DATA attribute for files > 1 KB
- \$DATA attribute for \$Boot
- \$DATA attribute for \$MFTMirr
- \$DATA attribute for \$LogFile

Hard Disk Drives Review

- Factory low-level formatting defines tracks and sectors on a blank disk
 - A track contains many sectors
 - A sector is typically 512 bytes
 - A sector is the minimum I/O unit

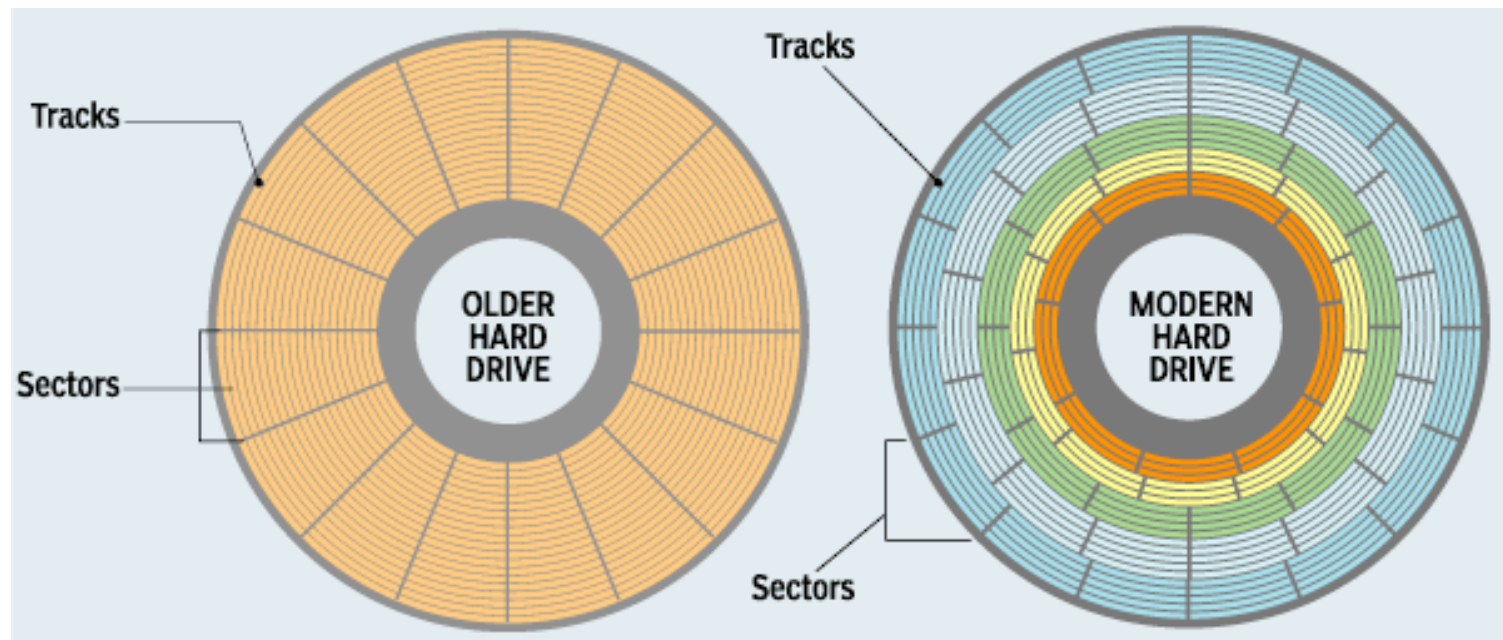

Clusters

- A cluster is a group of consecutive sectors
- A cluster is the minimum file allocation unit
- The number of sectors per cluster is a power of 2
 - The number is stored in the volume boot sector
 - Typical values are $2^1=2$, $2^2=4$, $2^3=8$, $2^4=16$

Partitions

- The user creates partitions (logical drives or volumes)
 - Each partition holds a file system
 - FAT12, FAT16, FAT32, NTFS on Windows systems
 - EXT2, EXT3, UFS1, UFS2 on Linux and UNIX systems

File Systems

- High-level formatting creates file system data structures
 - Root directory
 - Data that tracks which clusters are unused, allowing the OS to find available clusters quickly
 - File Allocation Table (FAT) on older Windows systems
 - \$Bitmap file in the Master File Table (MFT) on newer Windows systems

DOS Disk Review

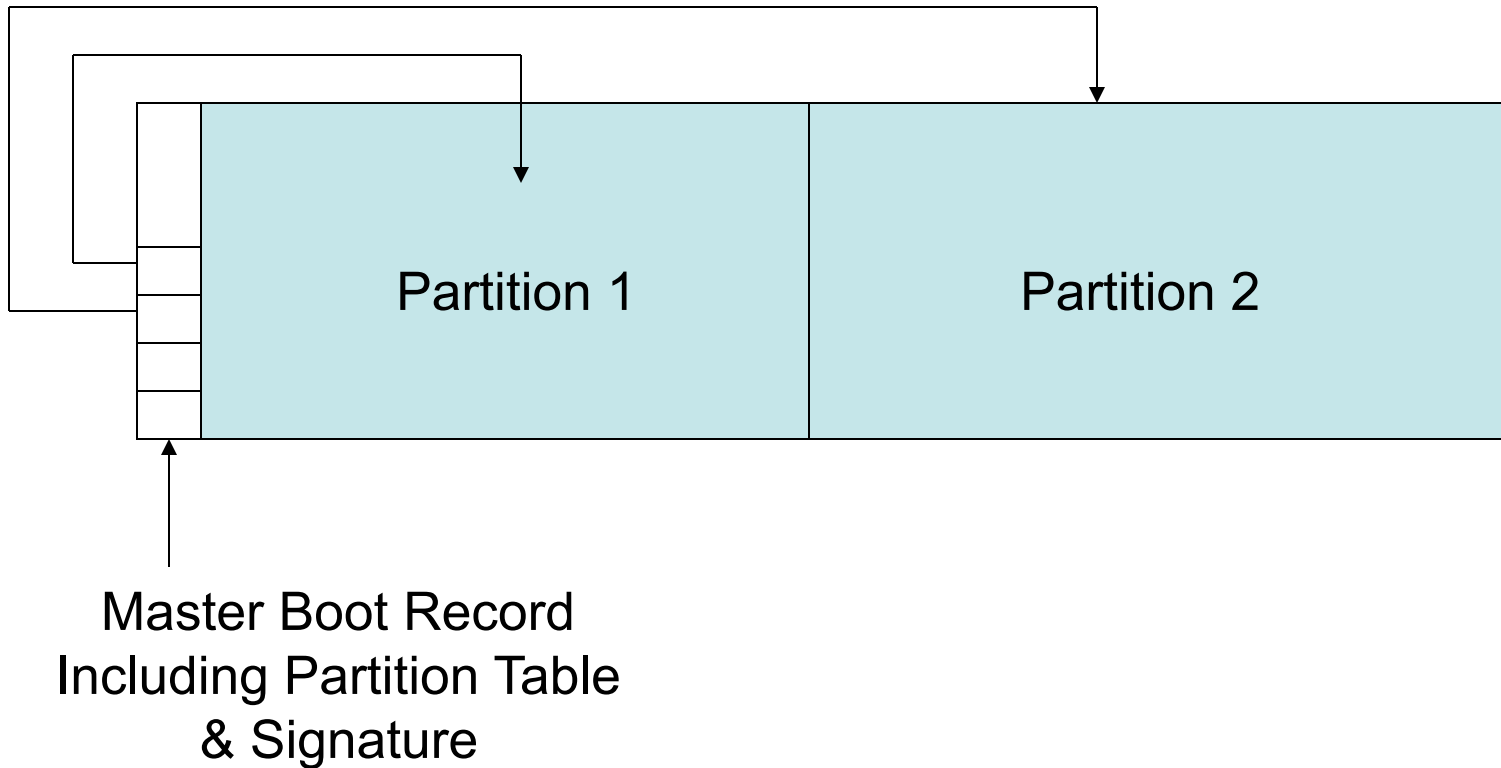

Partition Holds an NTFS File System

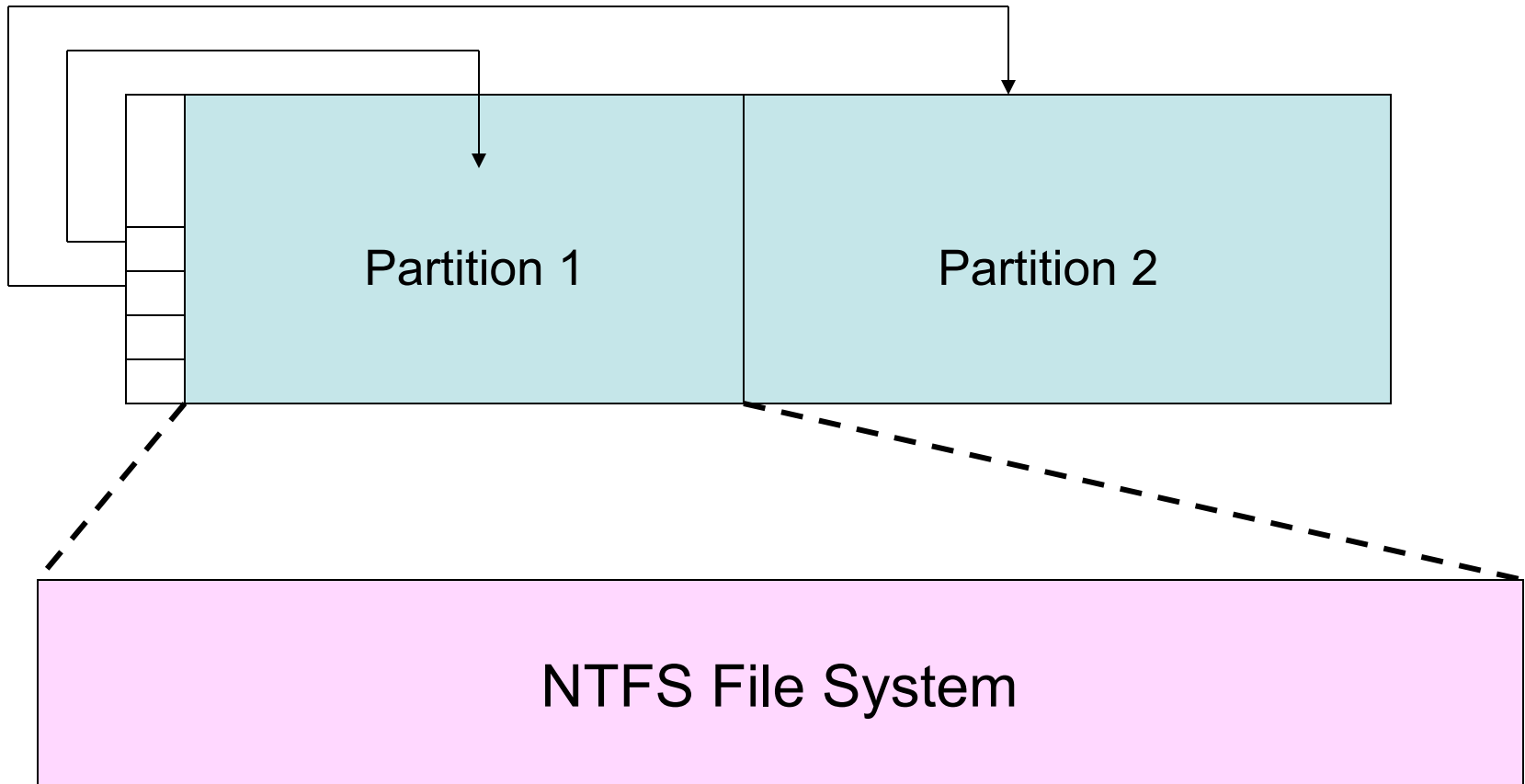

NTFS: Everything Is a File

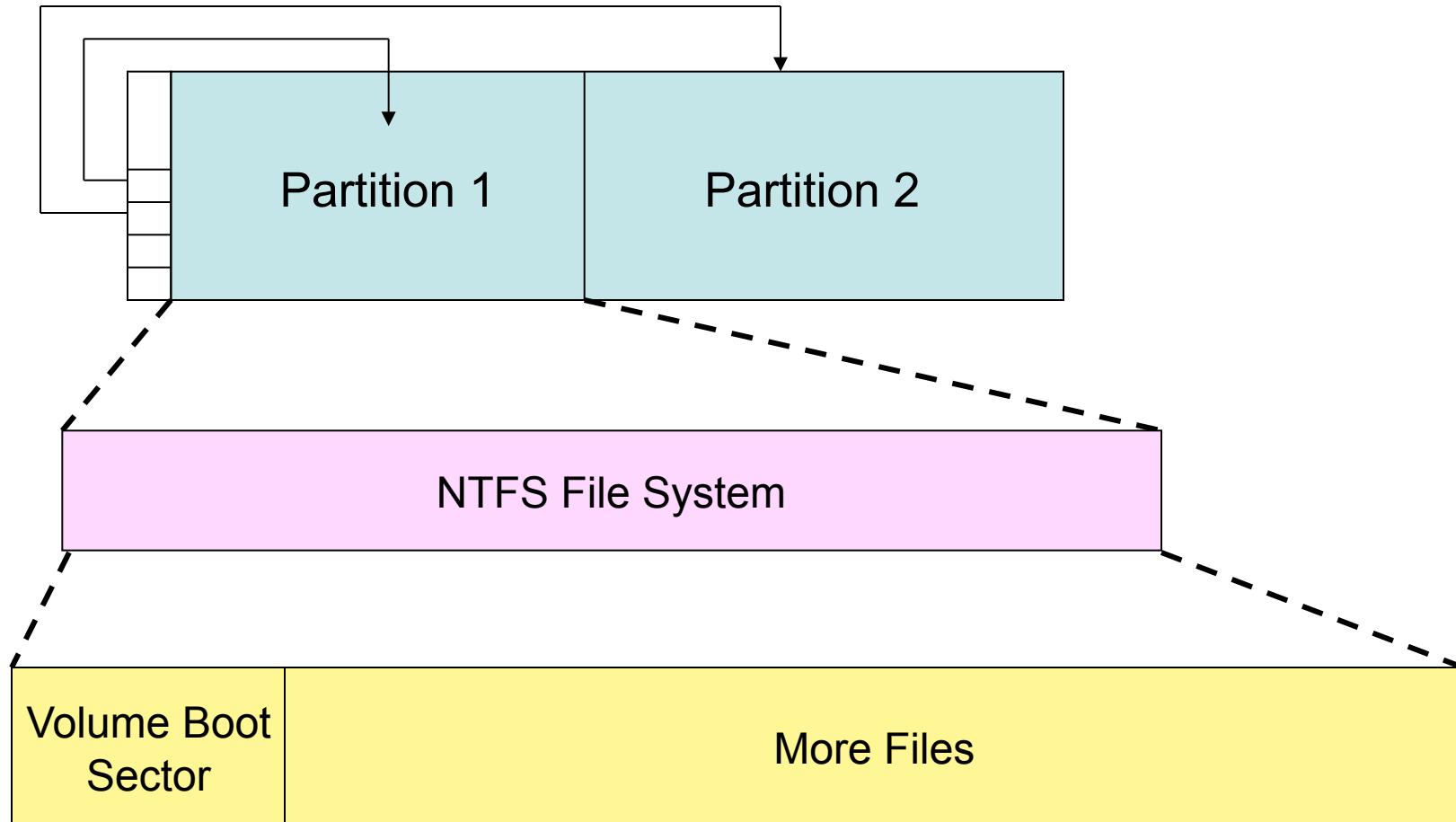

NTFS Volume Boot Sector

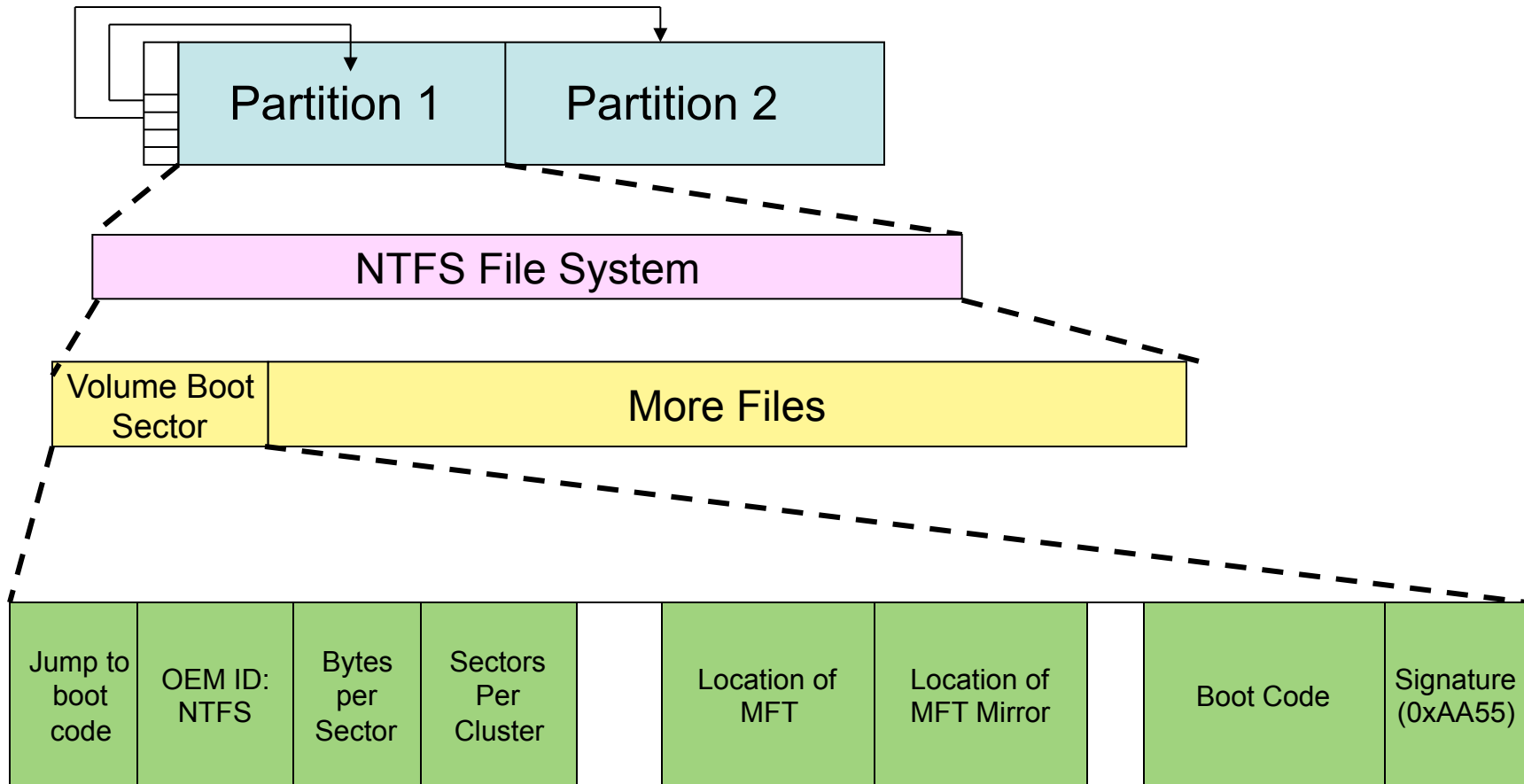

A Freshly Formatted NTFS Volume

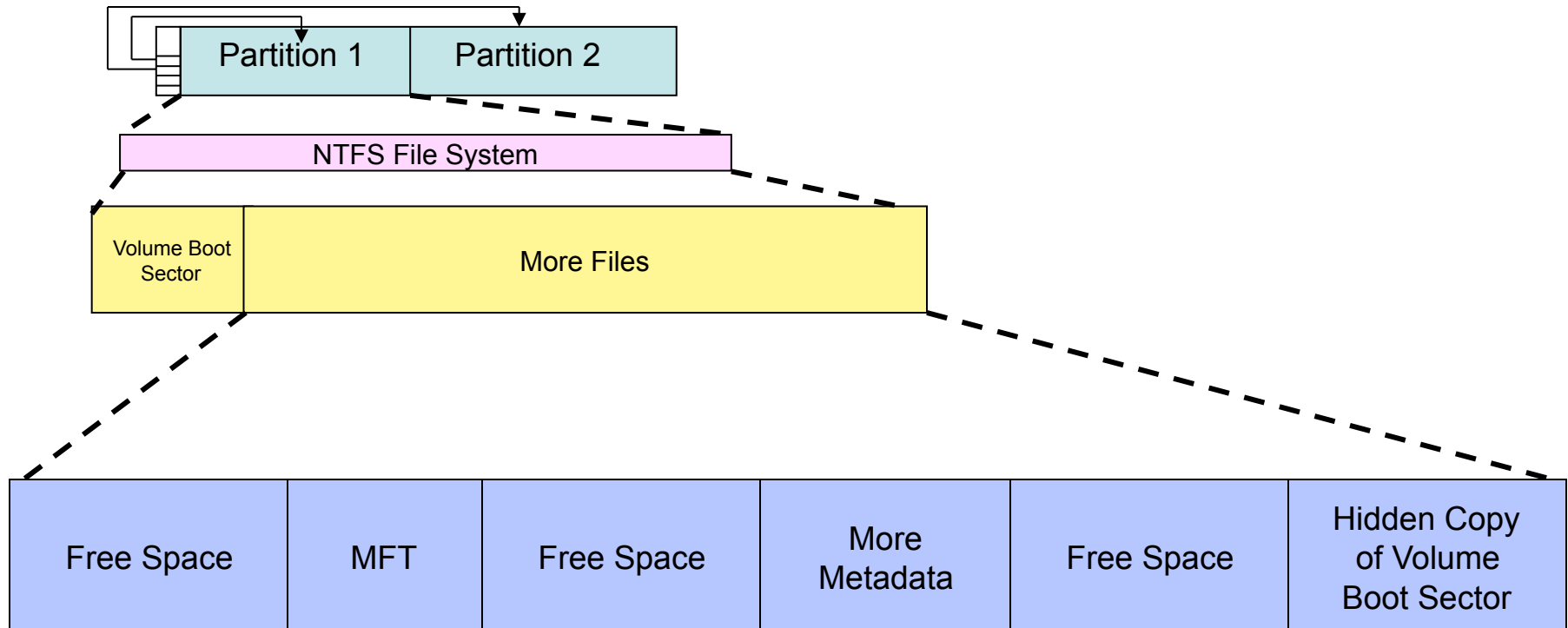

Metadata in Center of Volume

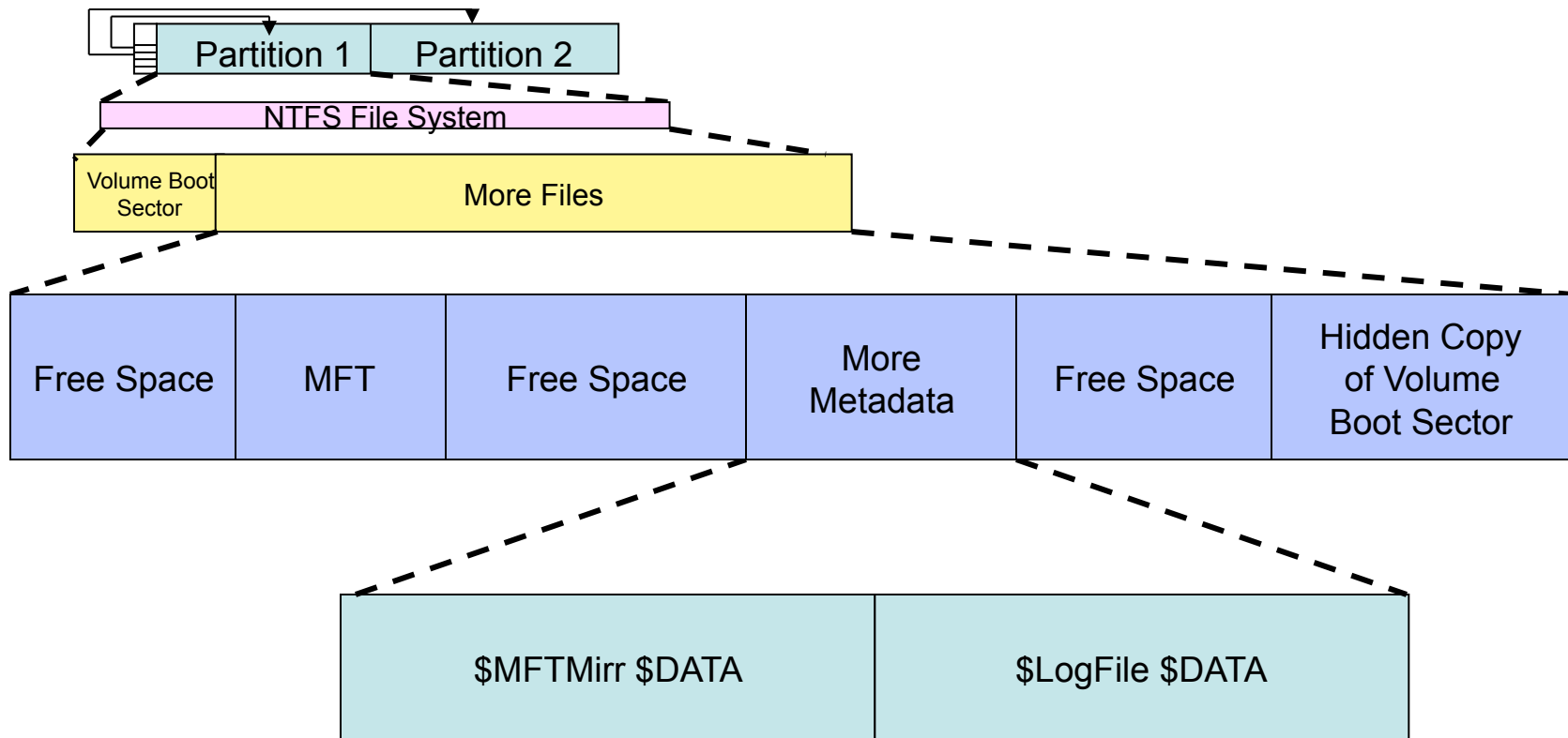

MFT

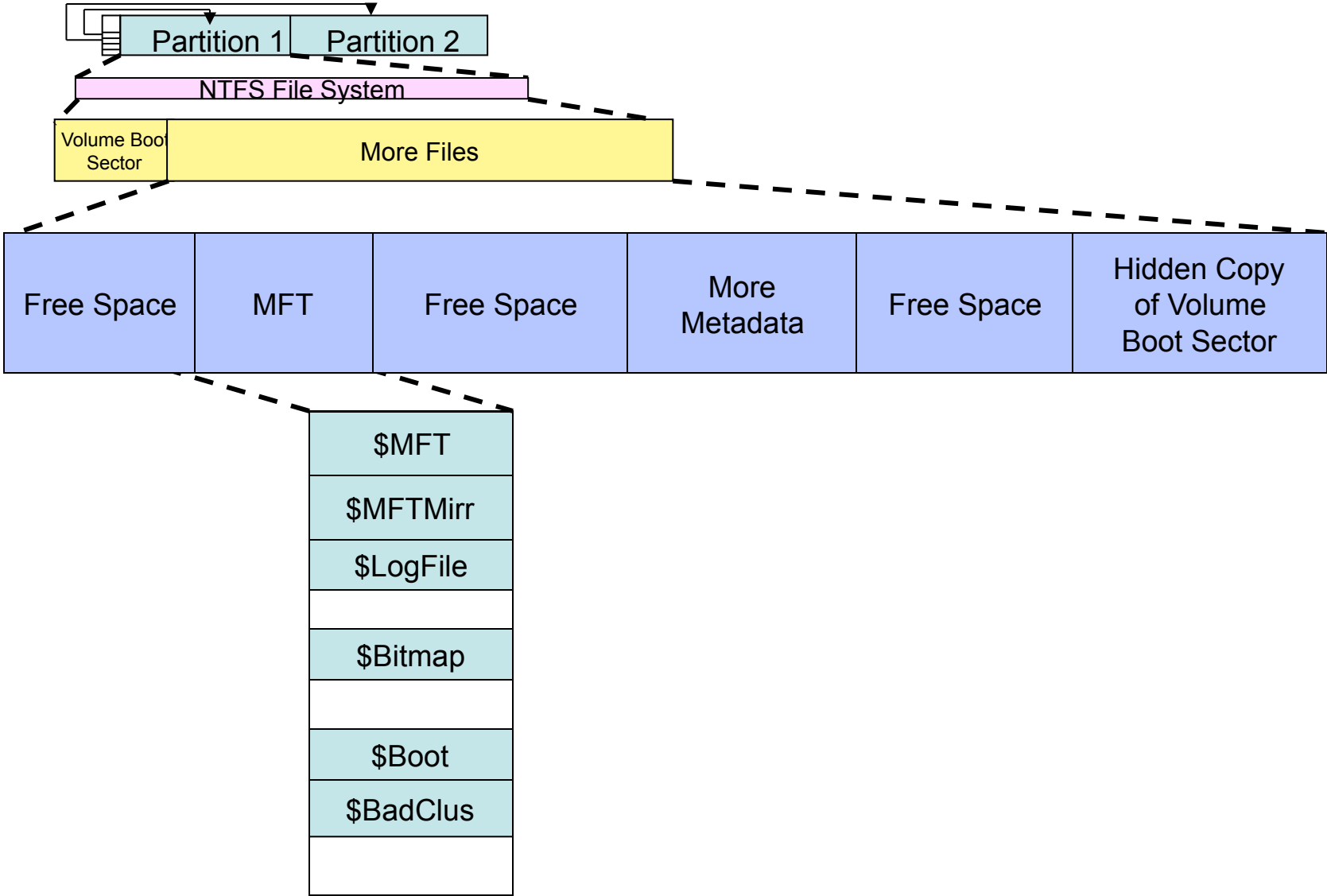

MFT Attributes

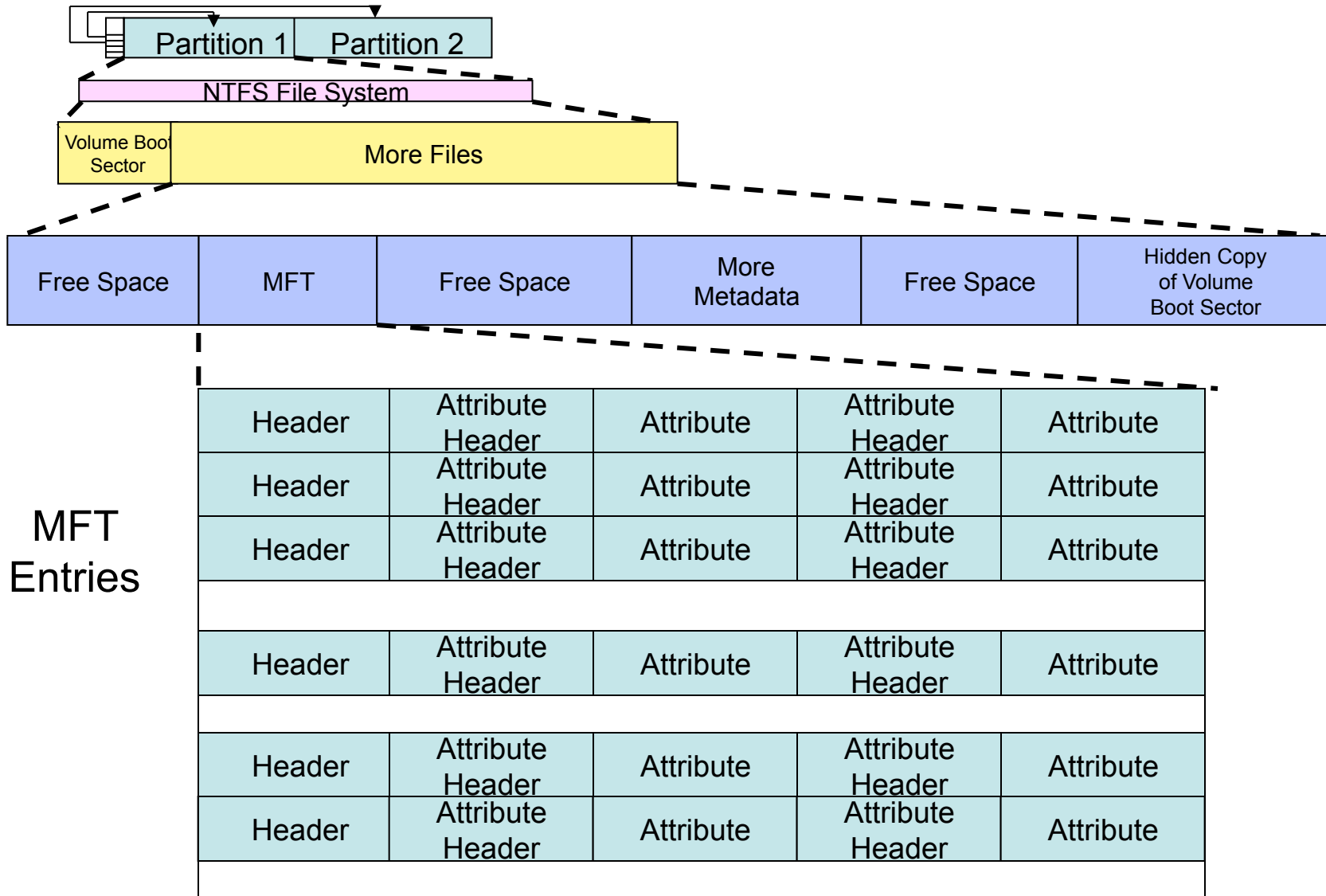

MFT Entries

MFT Entry Header

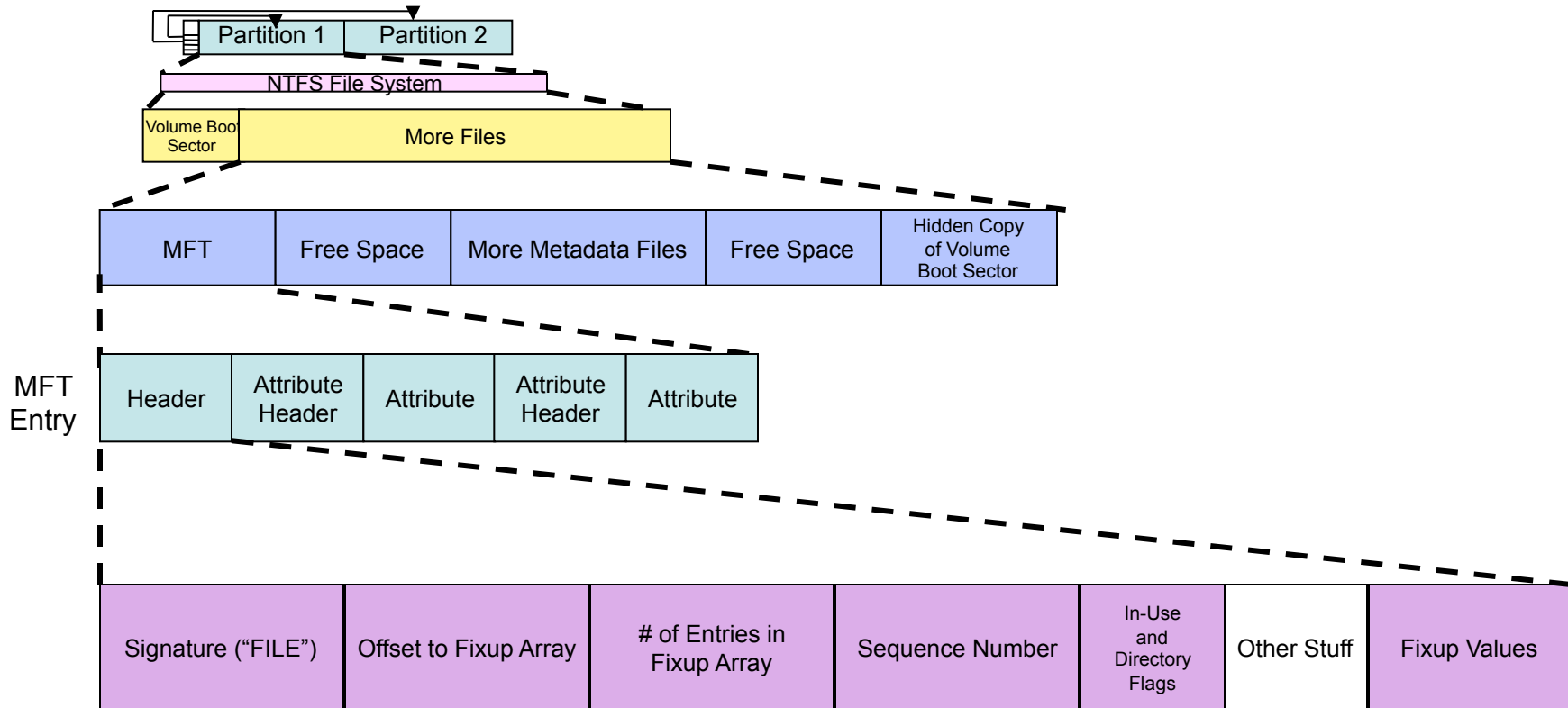

Creating an NTFS File

Creating dir1\file1.txt

1. Read volume boot sector to locate MFT.
2. Read first entry in MFT to determine layout of MFT.
3. Allocate an MFT entry for the new file.
4. Initialize MFT entry with \$STANDARD_INFORMATION, In-Use Flag, etc.
5. Check MFT \$Bitmap to find free clusters, using best-fit algorithm.
6. Set corresponding \$Bitmap bits to 1.
7. Write file content to clusters and update \$DATA attribute with starting address of cluster run and run length.
8. Read root directory (MFT entry 5), traverse index, and find dir1.
9. Read \$INDEX_ROOT attribute for dir1 and determine where file1.txt should go.
10. Create new index entry; resort index tree.
11. Enter steps in \$LogFile (as each step is taken).

An NTFS File

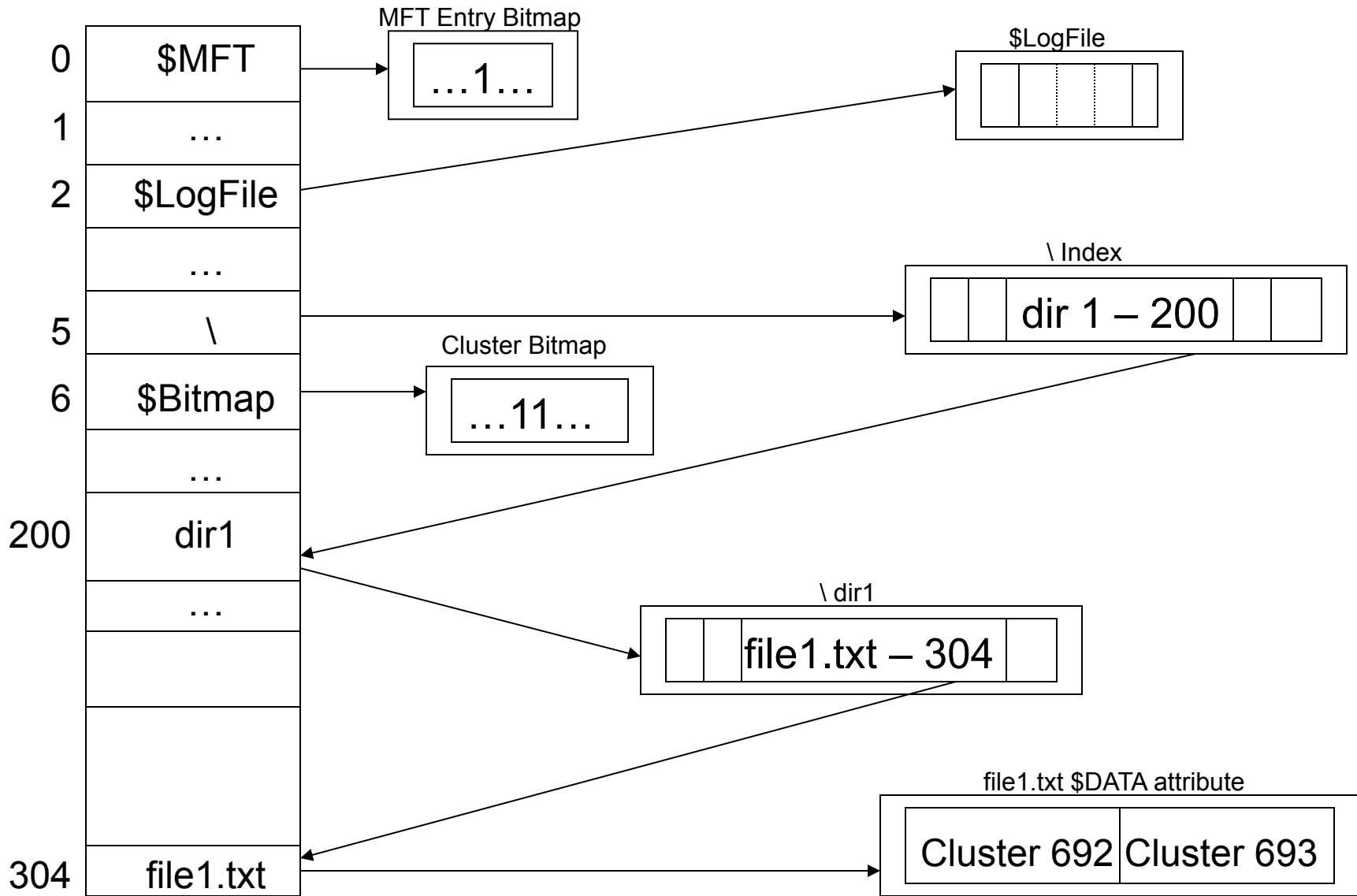

NTFS File Deleted

Data in blue boxes is unallocated

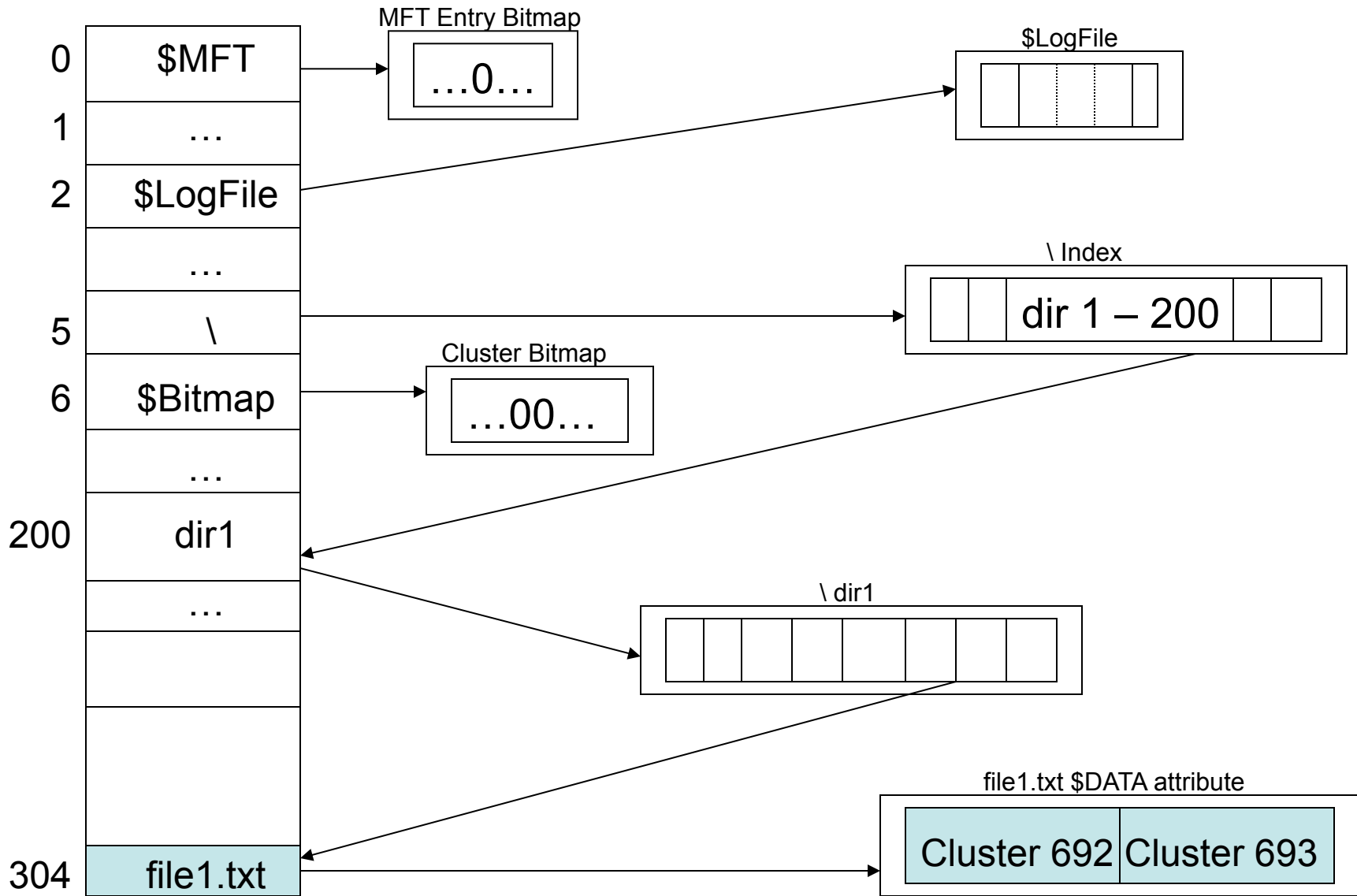

Deleting an NTFS File

Deleting dir1\file1.txt

1. Read volume boot sector to locate MFT.
2. Read first entry in MFT to determine layout of MFT.
3. Read root directory (MFT entry 5), traverse index, and find dir1.
4. Read \$INDEX_ROOT for dir1 entry and find file1.txt entry.
5. Remove filename entry from index; move other entries over.
6. Unallocate MFT entry and clean In-Use Flag.
7. Set MFT \$Bitmap entries to 0.
8. Enter steps in \$LogFile (as each step is taken).

Summary

- NTFS is more complicated than FAT but also has more scalability, reliability, and security features
- Forensics analysis and recovery of files is possible especially if \$MFT or \$MFTMirr are in good shape
- Recovery challenges include compression and encryption